



# Comparison of Wastewater Treatment Technologies

CBWM and Operator Training

November 2023

# Wastewater Treatment

- Household sanitary
- Industrial
- Commercial
- Institutional

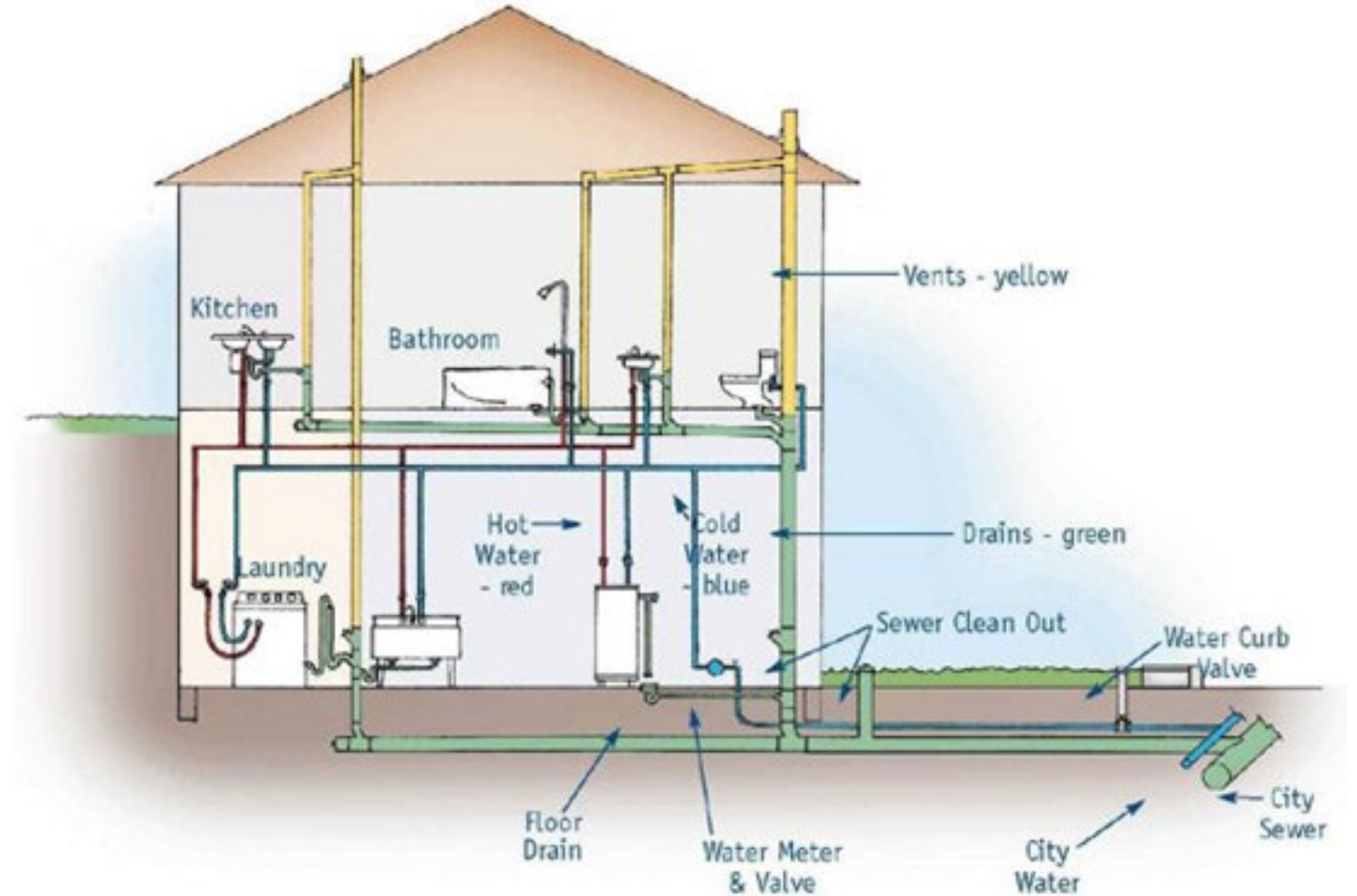

# Wastewater Treatment

- Pollutants
  - Organics
  - Inorganics
  - Solids



# Wastewater Treatment

- Pollutants (cont'd)
  - Nutrients
  - Fat / oil / grease
  - Pathogens
  - Metals

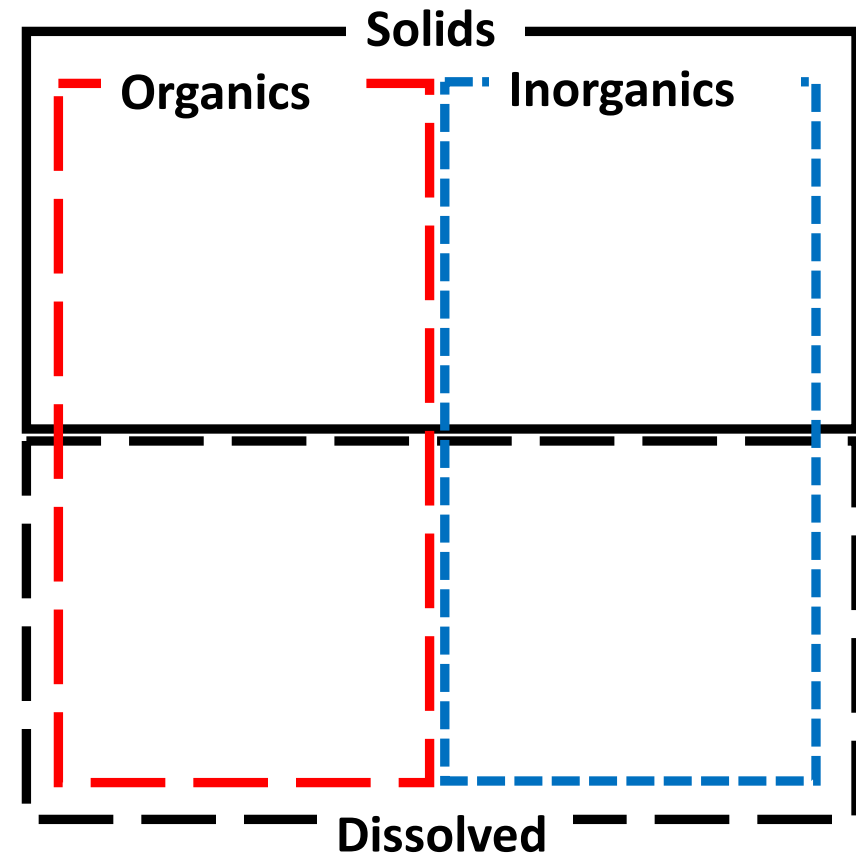



# Wastewater Treatment

- Reduce negative impacts:
  - Receiving waters
  - Natural environment



# Wastewater Treatment

- Levels of Wastewater Treatment
  - Preliminary
  - Primary
  - Secondary
  - Tertiary

# Wastewater Overview

- Preliminary Treatment
  - Screen
  - Comminution
  - Grit removal
  - Scum / FOG removal

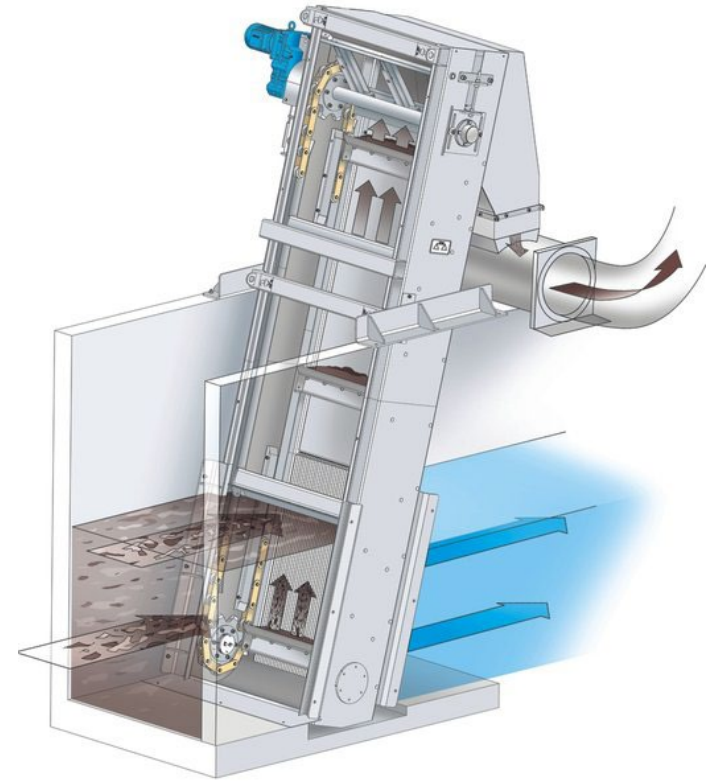
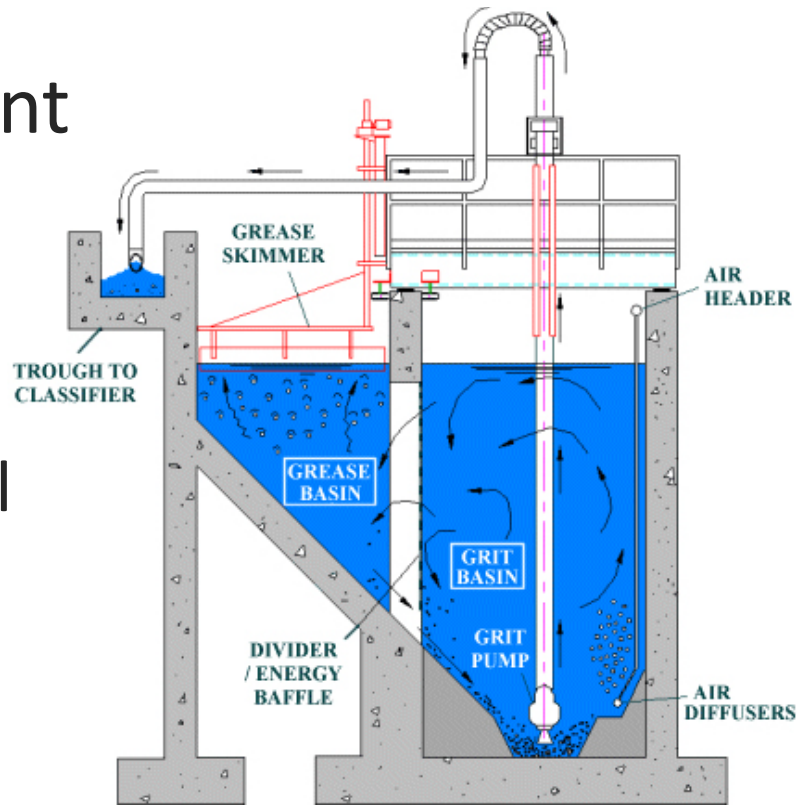

# Wastewater Overview

- Primary Settling

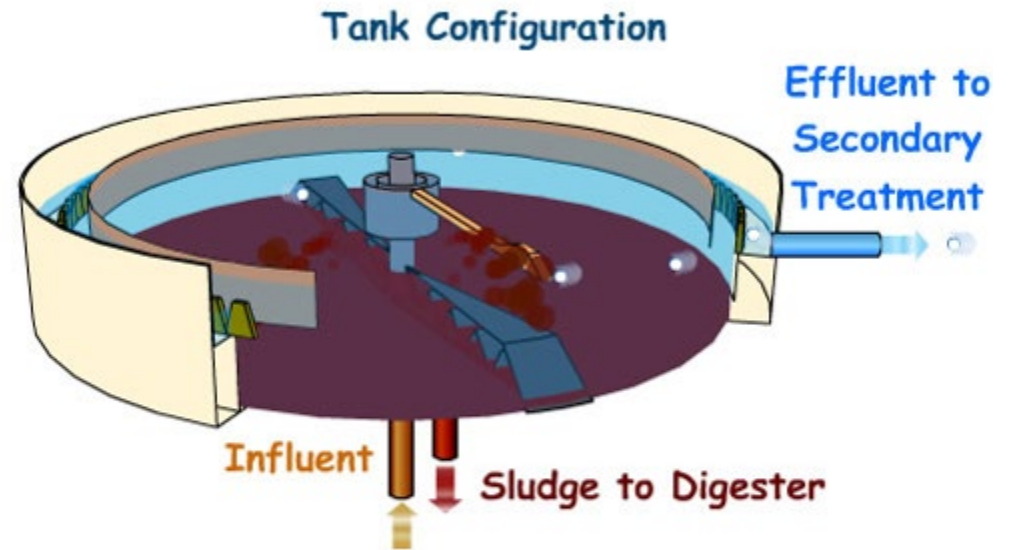



# Wastewater Overview

- Biological Treatment

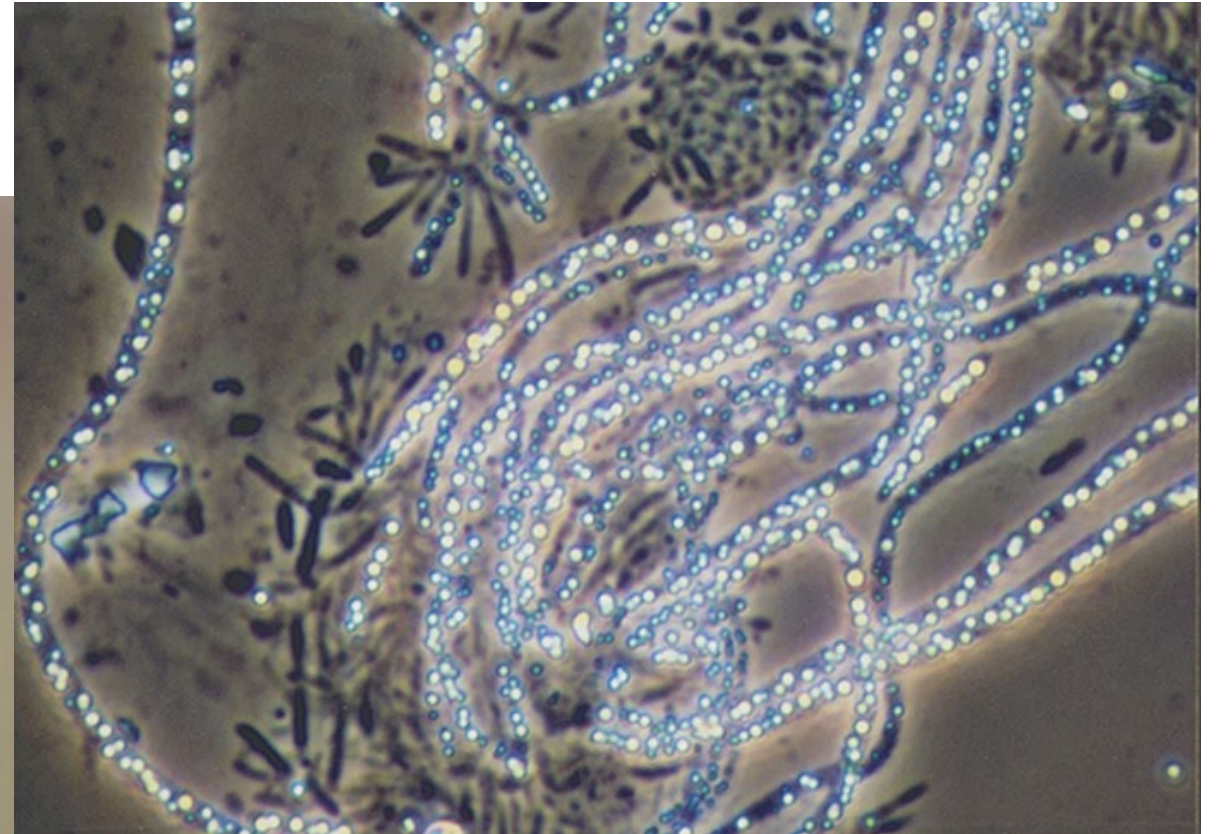
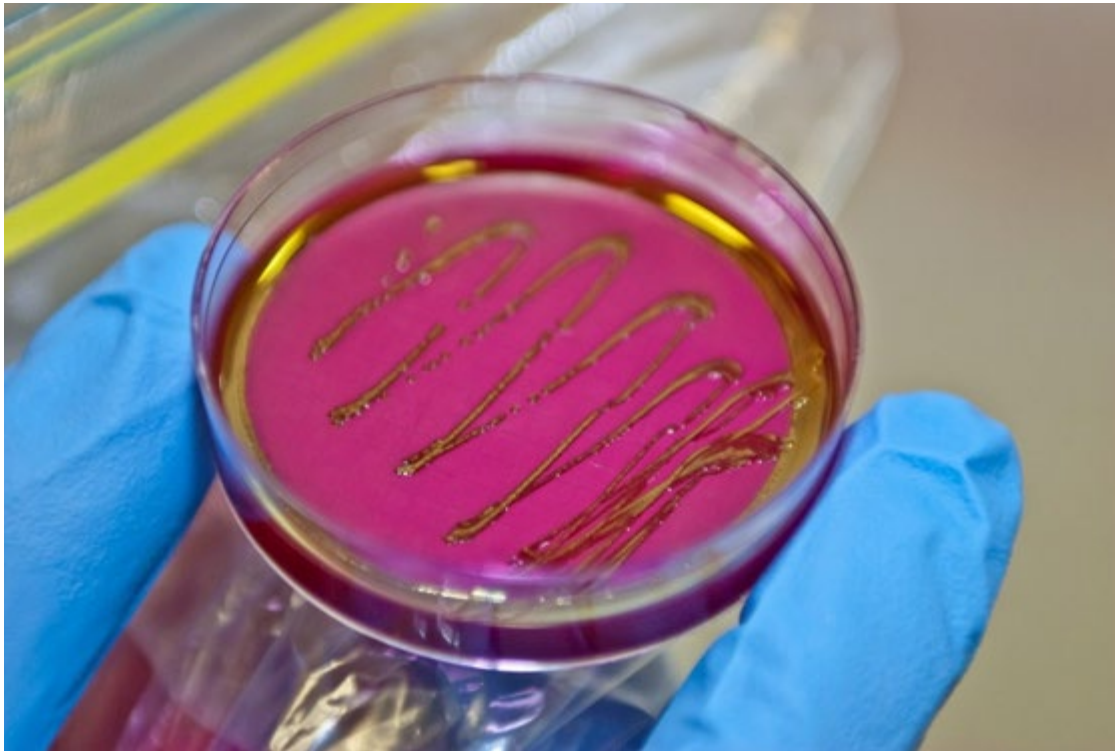

# Wastewater Overview

- Biological Treatment – Septic System

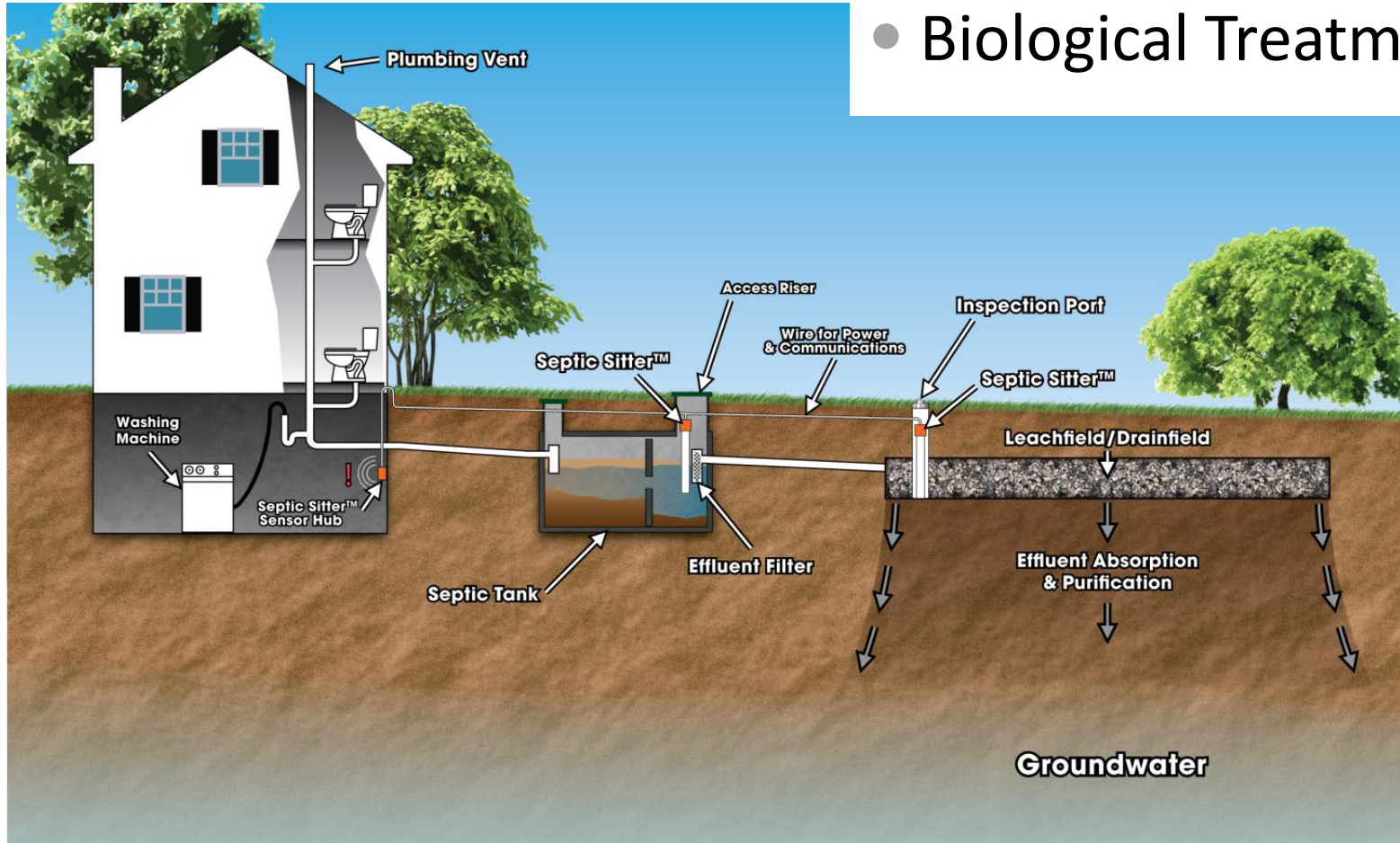



# Wastewater Overview

- Biological Treatment – Activated Sludge

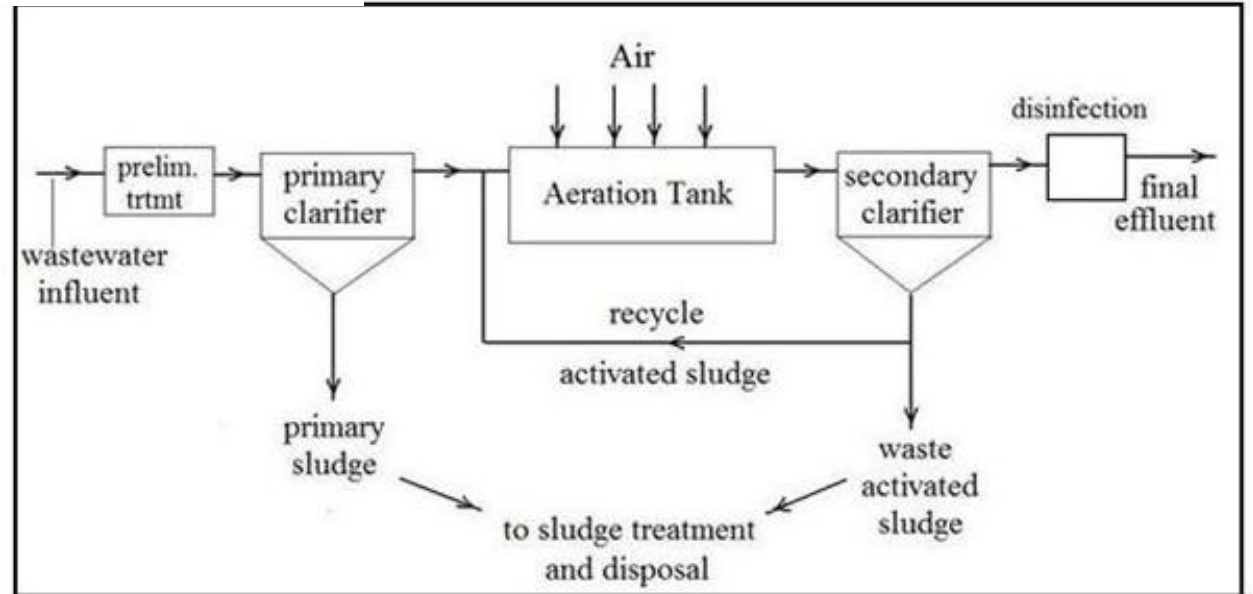

Activated Sludge Wastewater Treatment Flow Diagram

# Wastewater Overview

- Biological Treatment – Rotating Biological Contactor

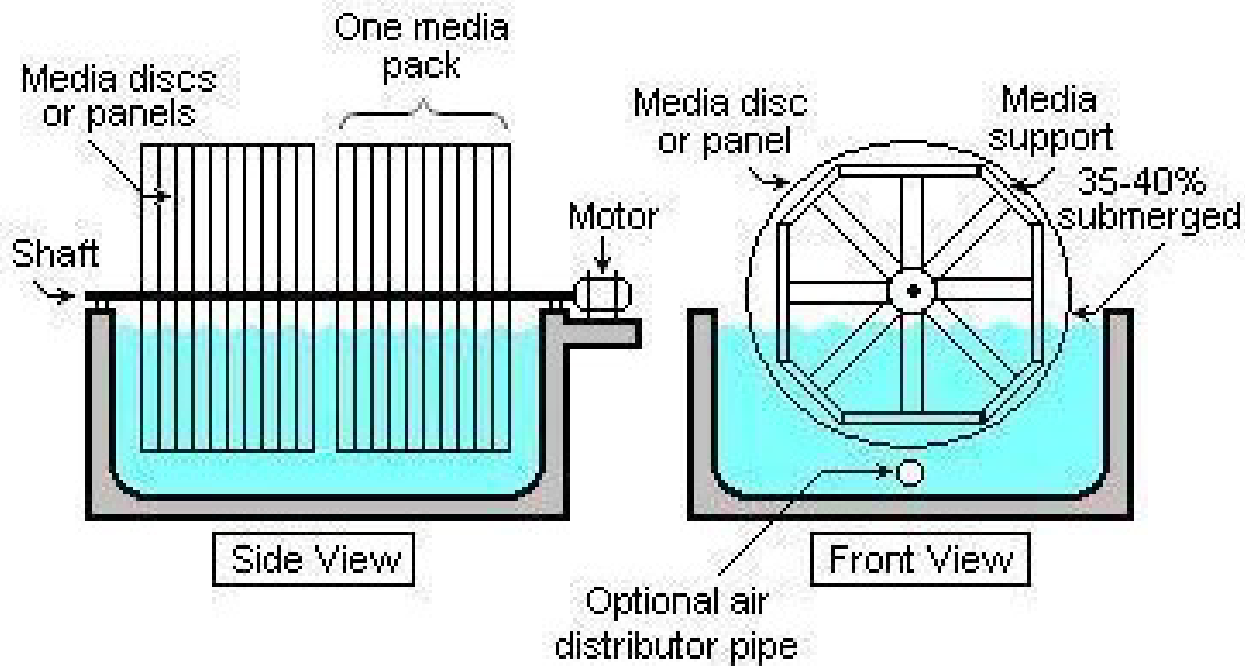



# Wastewater Overview

- Biological Treatment – Fixed Film Reactor

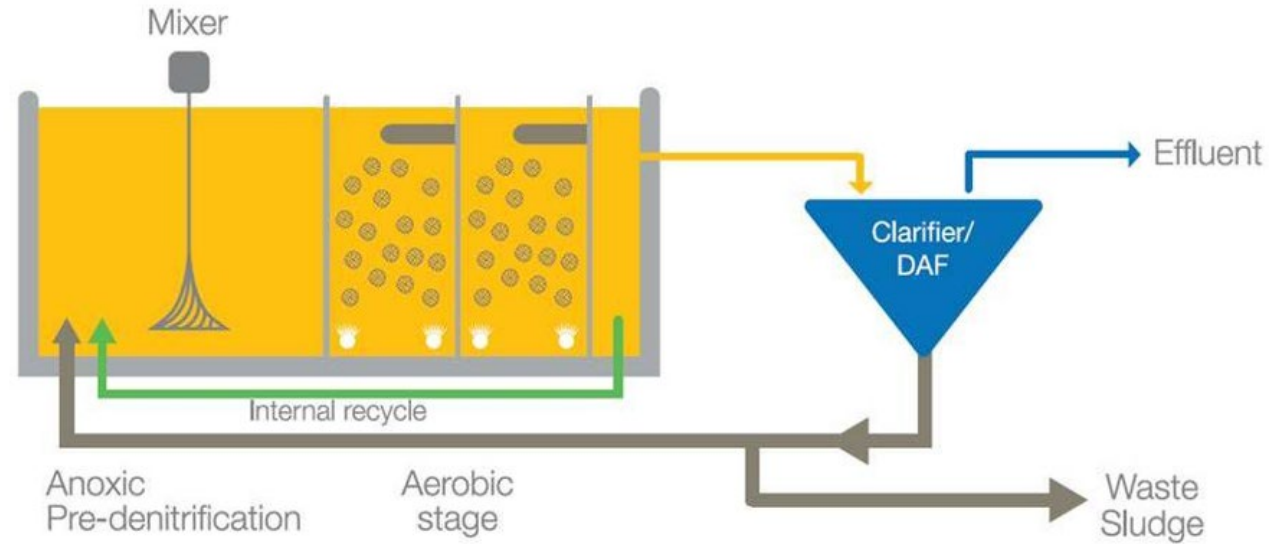
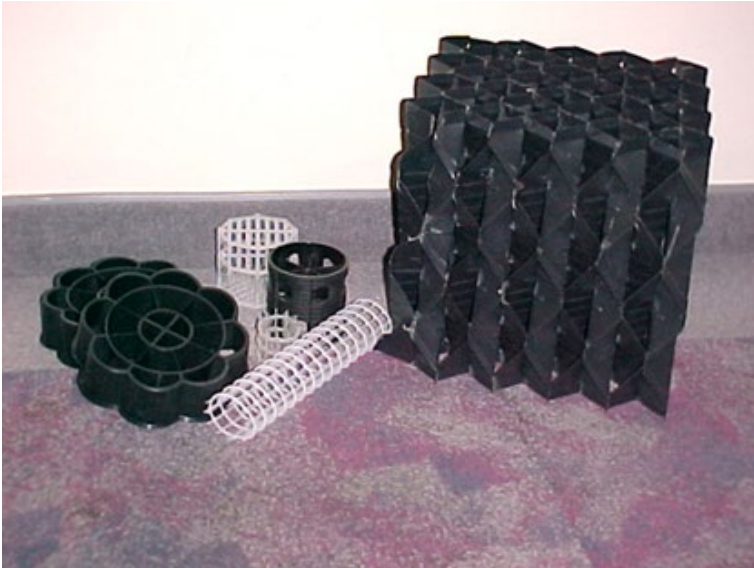

# Wastewater Overview

- Biological Treatment – Secondary Clarification



# Wastewater Overview

- Biological Treatment – DAF

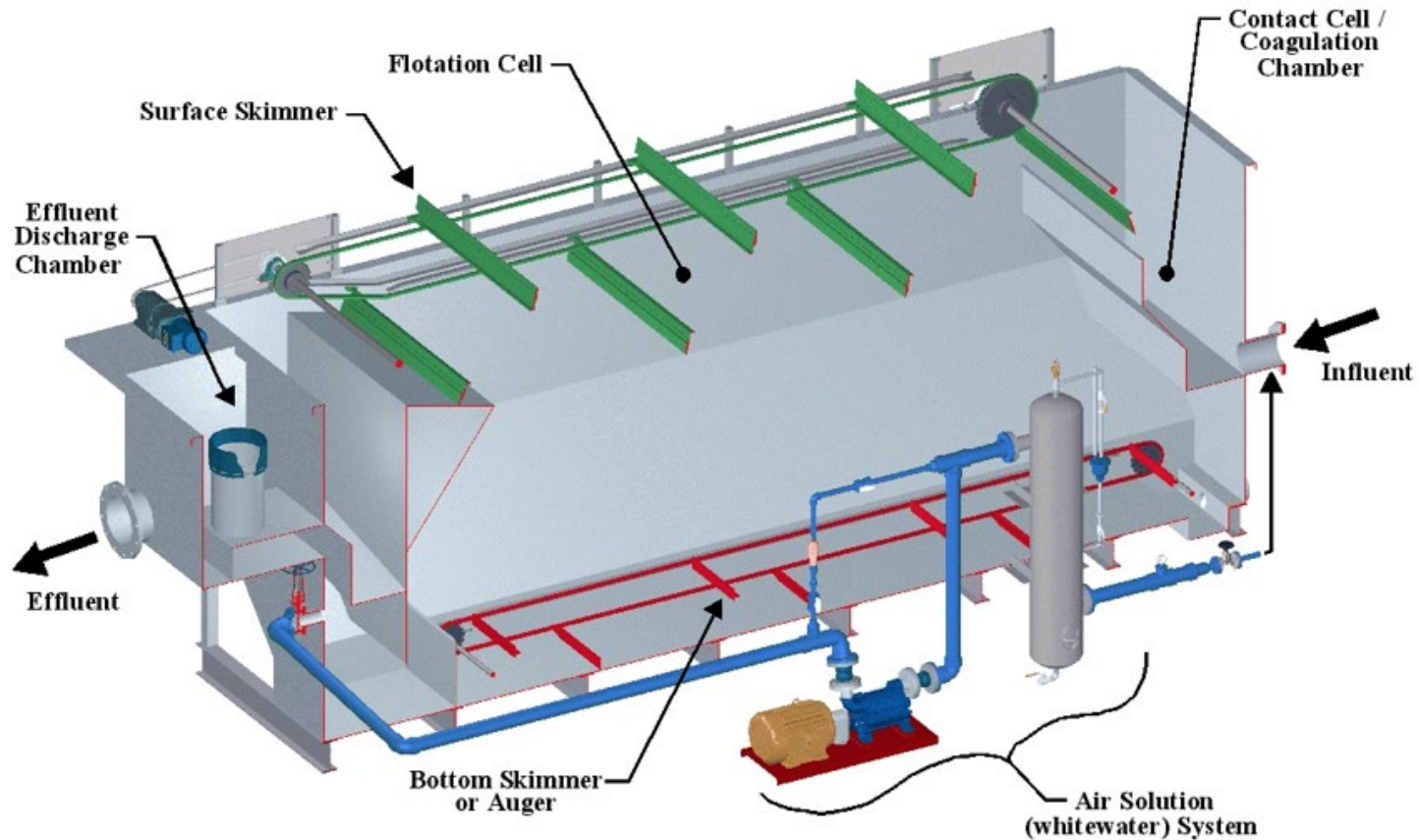

# Wastewater Overview

- Biological Treatment – Lagoon





# Wastewater Overview

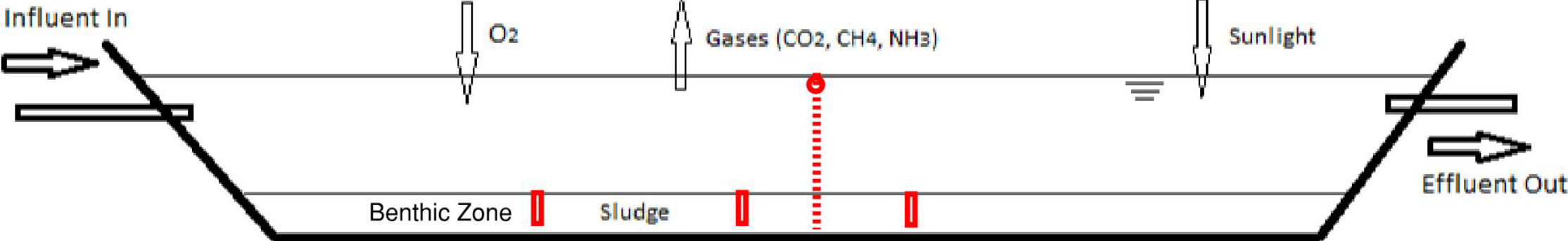

Lagoon Section

# Wastewater Overview



# Wastewater Overview

- Activated Sludge vs Lagoon



- Operating Sequence for SBR

Idle

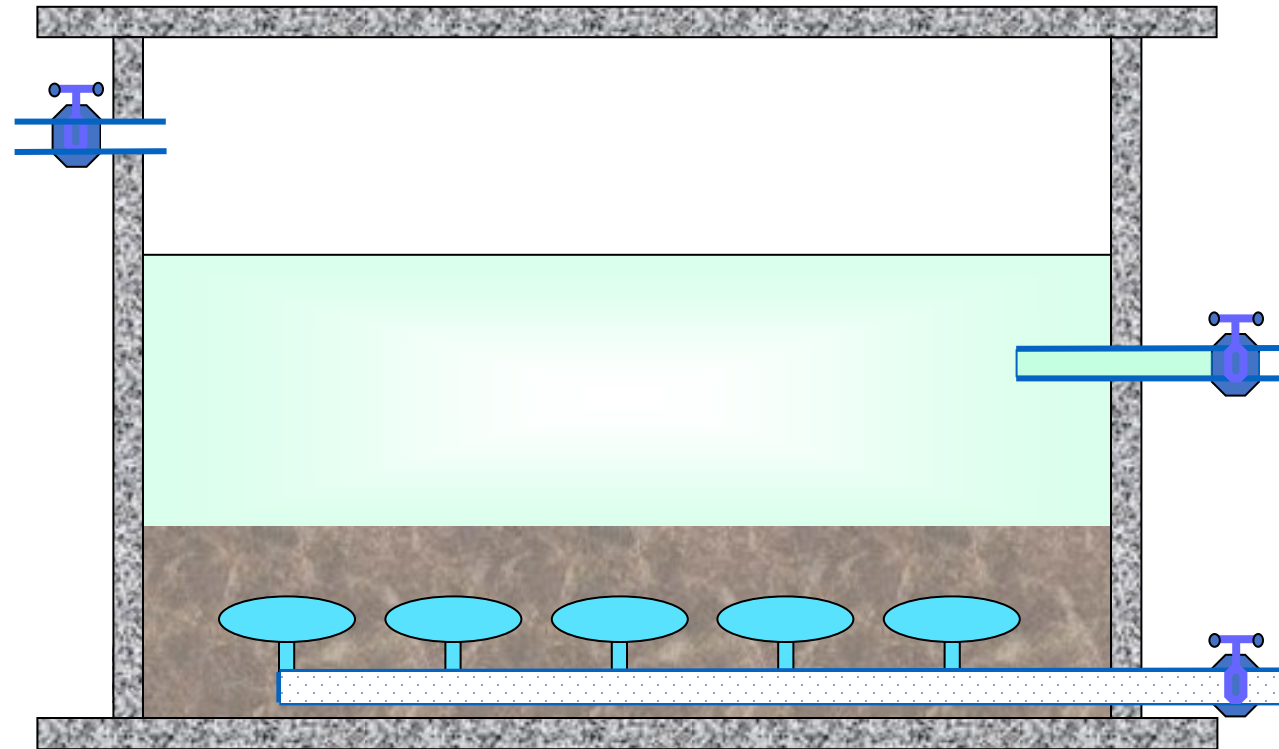



- Operating Sequence for SBR

Fill

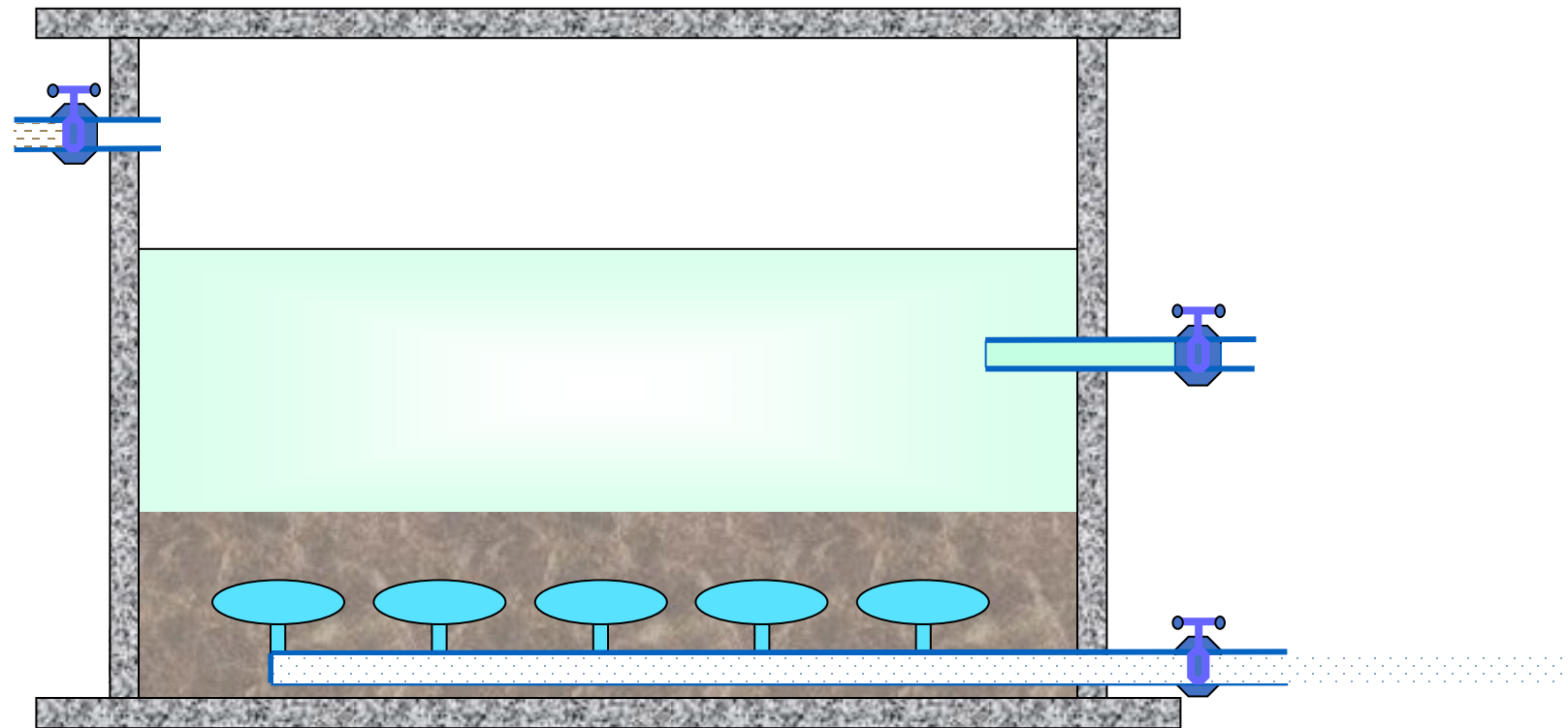

- Operating Sequence for SBR

React

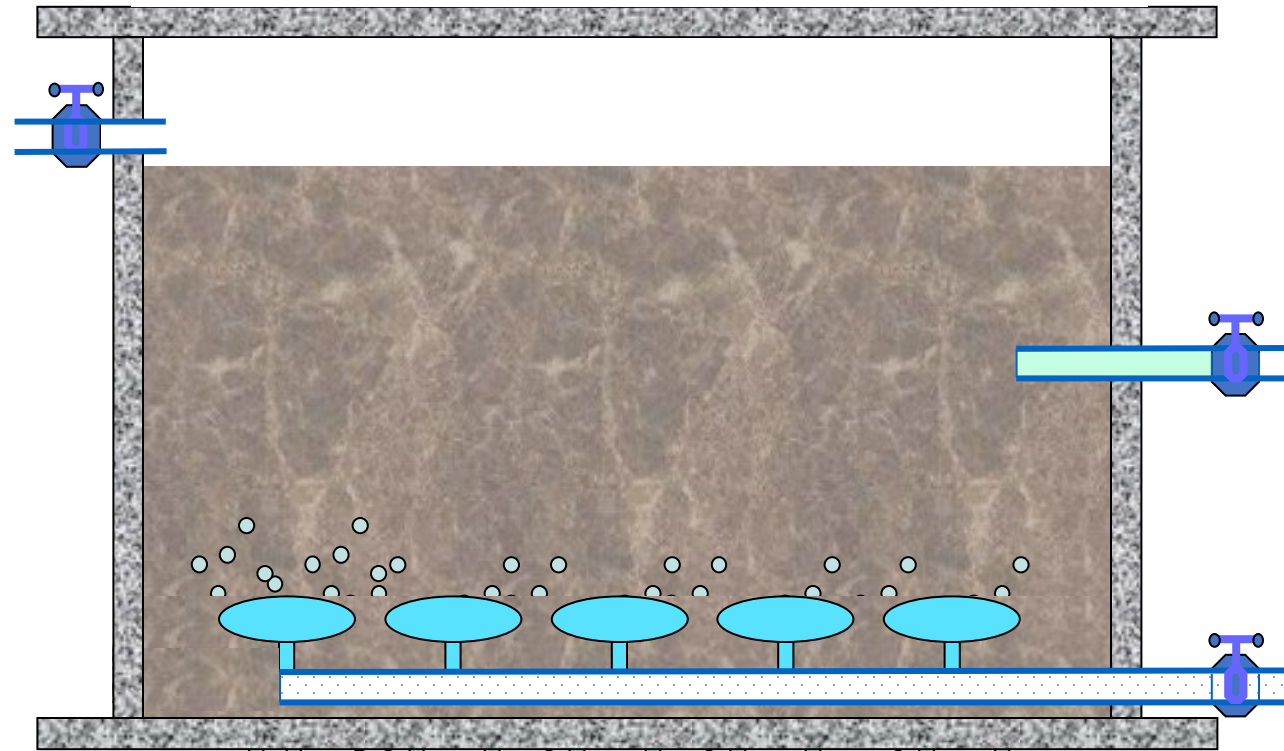

- Operating Sequence for SBR

Settle

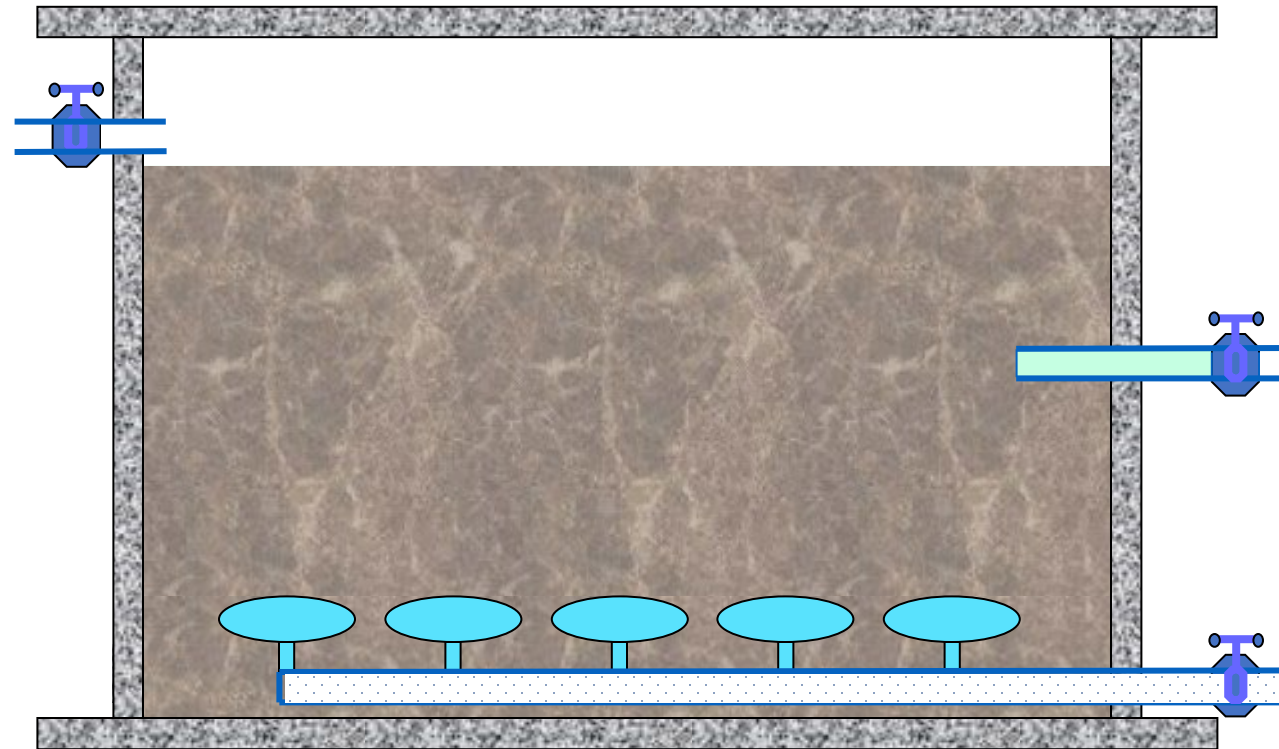

# Wastewater Overview

- Tertiary Treatment
  - Reduction of nutrients
  - Reduction of suspended solids & organics

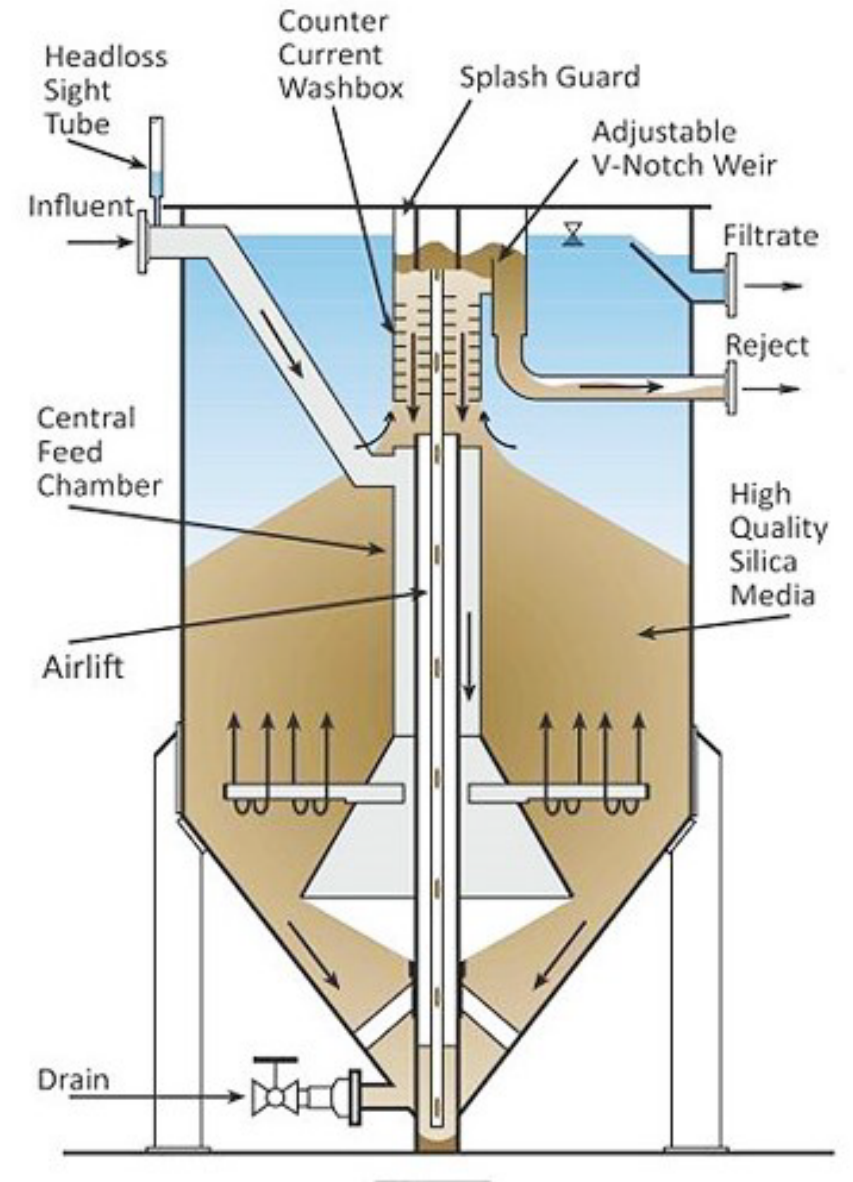



# Wastewater Overview

- Membrane Bioreactor

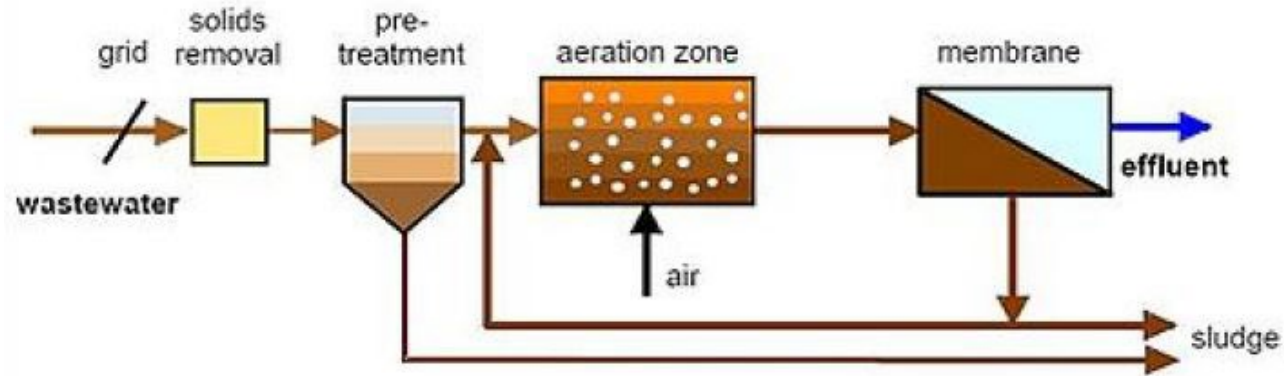
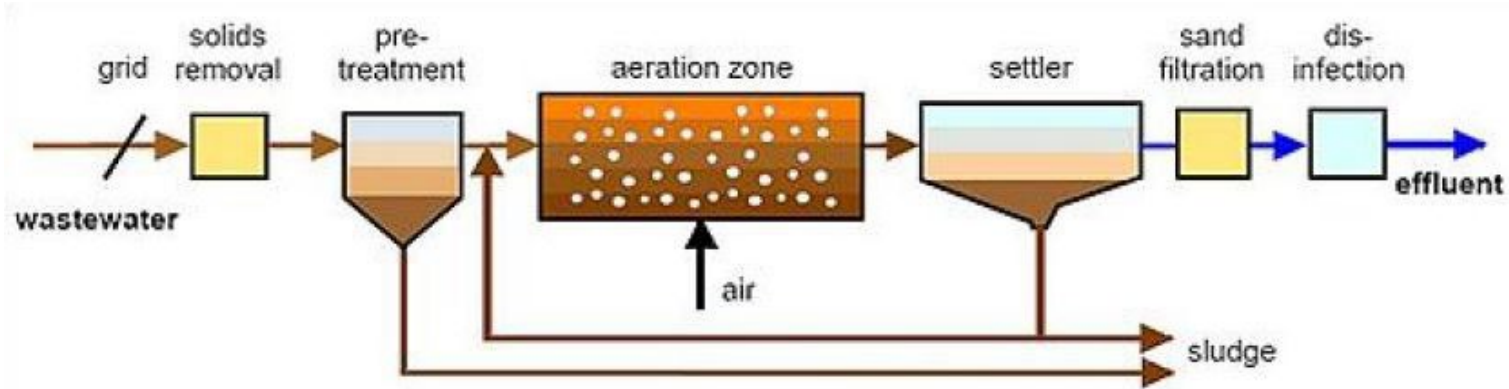



**Thank you**